

ST 050 309 2892



- shower with fixed riser projection 420mm
- Rain shower: PURE RAIN, max. flow rate 14 l/min (at 3 bar)
- rain shower Ø 300 mm
- rain shower with anti-scale system
- Hand shower: COMPACT RAIN, max. flow rate 6.8 l/min (at 3 bar)
- spray head Ø 100mm
- rotary diverter for fixed-riser shower/hand shower
- height of fittings up to rain shower (bottom edge) 850mm
- height of fittings up to top edge of elbow 1167mm
- rosette for shower holder Ø 55mm
- rosette for wall mounting Ø 57mm
- rosette for shower mixer Ø 65mm
- gauge 150 mm - 13 mm
- 1500 mm metal shower hose
- 1/2" connection
- Pipe diameter 20 mm

	Chrome	ST 050 309 2892-00
	Brushed Platinum	ST 050 309 2892-06
	Platinum	ST 050 309 2892-08
	Dark Chrome	ST 050 309 2892-19
	Brushed Durabross (23kt Gold)	ST 050 309 2892-28
	Matte Black	ST 050 309 2892-33
	Brushed Champagne (22kt Gold)	ST 050 309 2892-46
	Champagne (22kt Gold)	ST 050 309 2892-47
	Brushed Chrome	ST 050 309 2892-93
	Brushed Dark Platinum	ST 050 309 2892-99

**Individual components of this set**

You need the following components for this set



1x 26 622 892-00 0050



1x 28 018 979-00 0050



## TARA Shower pipe with shower mixer 300 mm - Chrome

---

TARA

ST 050 309 2892

ST 050 309 2892



- shower with fixed riser projection 420mm
- overhead shower: rain flow
- rain shower Ø 300 mm
- rain shower with anti-scale system
- max. rainshower flow 14 l/min
- rotary diverter for fixed-riser shower/hand shower
- height of fittings up to rain shower (bottom edge) 850mm
- height of fittings up to top edge of elbow 1167mm
- rosette for shower holder Ø 55mm
- rosette for wall mounting Ø 57mm
- rosette for shower mixer Ø 65mm
- gauge 150 mm - 13 mm
- 1500 mm metal shower hose
- 1/2" connection
- Pipe diameter 20 mm
- quick clearing

This article does not include a hand shower!  
Intrinsic protection against back flow.

	Chrome	26 622 892-00 0050
	Brushed Platinum	26 622 892-06 0050
	Platinum	26 622 892-08 0050
	Dark Chrome	26 622 892-19 0050
	Brushed Durabronze (23kt Gold)	26 622 892-28 0050
	Matte Black	26 622 892-33 0050
	Brushed Champagne (22kt Gold)	26 622 892-46 0050
	Champagne (22kt Gold)	26 622 892-47 0050
	Brushed Chrome	26 622 892-93 0050
	Brushed Dark Platinum	26 622 892-99 0050

ST 050 309 2892

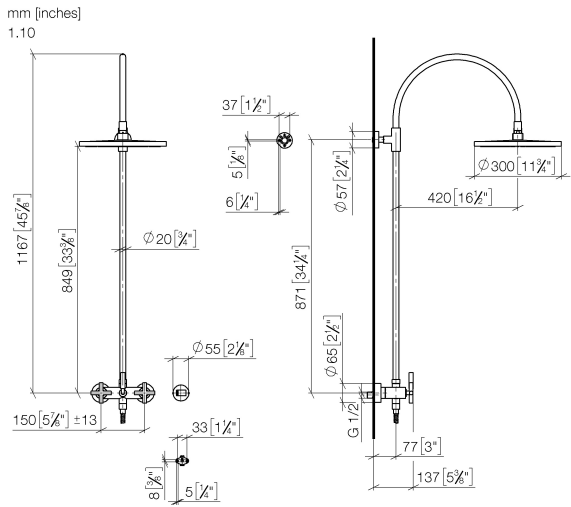

**Flow rate chart**

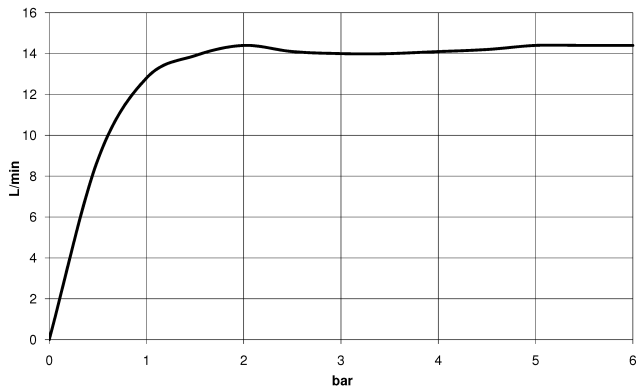

ST 050 309 2892

Parts for other finishes can be found here: Brushed Platinum

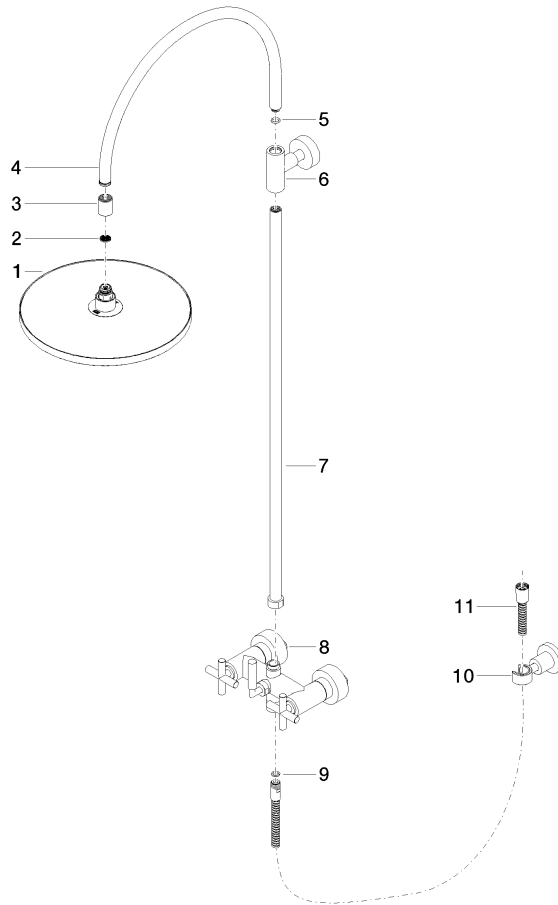

### Spare parts list

No.	Item Number	Name	Quantity used	Delivery time
1	04 12 05 091 10-00	shower	1	10
2	09 23 01 039 90	sieve	1	2
3	09 24 03 177 20-00	adaptor	1	10
4	04 28 22 097 20-00	spout	1	10
5	90 14 10 011 00 90	seal	1	2
6	90 17 11 037 00-00	holder	1	10
7	90 28 22 096 00-00	pipe	1	10
8	04 17 10 020 01-00	fitting	1	10
9	90 14 20 026 00 90	seal	1	2
10	28 050 892-00	TARA Wall bracket - Chrome	1	10
11	28 304 970-00	Metal shower hose 1/2" x 3/8" x 1500 mm - Chrome	1	2















ST 050 309 2892



- Three or five settings: COMPACT RAIN, COMPACT SOFT FLOW, COMPACT AQUAPRESSURE FLOW, max. flow rate 6.8 l/min (at 3 bar)
- with anti-scale system
- spray head Ø 100mm
- 1/2" connection
- WRAS

Intrinsic protection against back flow.

Fits: IMO, LULU, MADISON, MEM, TARA, CL.1, LISSÉ, VAIA, META, CYO

	Chrome	28 018 979-00 0050
	Brushed Platinum	28 018 979-06 0050
	Platinum	28 018 979-08 0050
	Dark Chrome	28 018 979-19 0050
	Light Gold	28 018 979-26 0050
	Light Gold	28 018 979-26
	Brushed Light Gold	28 018 979-27 0050
	Brushed Light Gold	28 018 979-27
	Brushed Durabronze (23kt Gold)	28 018 979-28 0050
	Matte Black	28 018 979-33 0050
	Brushed Bronze	28 018 979-42 0050
	Brushed Champagne (22kt Gold)	28 018 979-46 0050
	Champagne (22kt Gold)	28 018 979-47 0050
	Brushed Chrome	28 018 979-93 0050
	Brushed Dark Platinum	28 018 979-99 0050



## TARA Shower pipe with shower mixer 300 mm - Chrome

---

TARA

ST 050 309 2892

ST 050 309 2892

mm [inches]

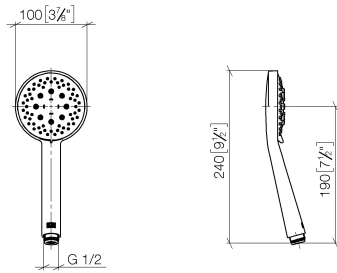

Flow rate chart

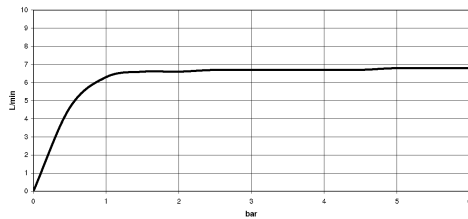

Spare parts list

No.	Item Number	Name	Quantity used	Delivery time
1	09 23 01 039 90	sieve	1	2